



# WHOLESALE SOLUTIONS

**SAVE NOW**

PLACE YOUR ORDER AT  
[PRO.NAPAPROLINK.COM](http://PRO.NAPAPROLINK.COM)

Pricing Valid

6/1/2026 - 6/30/2026

Visibility | Chemicals & Commodities | Replacement Parts | Fleet Maintenance | Accessories | Shop Supplies | Paint & Body

**NEW**

# MOBIL 1™ ADVANCED CLEAN

Discover what one oil change can do.



These sale prices are available only to NAPA contract/wholesale customers and are not available to retail customers.

NOW AVAILABLE AT



© 2026 ExxonMobil. Mobil, Mobil 1, and the 1 icon are trademarks or registered trademarks of Exxon Mobil Corporation or one of its subsidiaries. Other trademarks shown are property of their respective owners. All rights reserved.

# **NEW** Mobil 1™ Advanced Clean

# CLEANS YOUR ENGINE IN ONE OIL CHANGE.

Prevents up to  
100% of harmful  
sludge formation.\*

\*Based on Seq VH rocker  
cover sludge results.

Protects  
for 20,000 miles  
guaranteed.\*\*

\*\*Protects for 20,000 miles or  
1 year, whichever comes first.

Helps extend  
engine life.



Get full product details.



Keeps your engine  
running like new ***for longer***<sup>†</sup>

SKU	DESCRIPTION
128647	M1 ADV CLEAN 0W20 1QT
128645	M1 ADV CLEAN 5W20 1QT
128646	M1 ADV CLEAN 5W30 1QT

SKU	DESCRIPTION
128648	M1 ADV CLEAN 0W20 5QT
128649	M1 ADV CLEAN 5W20 5QT
128650	M1 ADV CLEAN 5W30 5QT

<sup>†</sup>Vs. GF-6 Mobil 1 motor oil ODI.  
© 2026 ExxonMobil. Mobil, Mobil 1, and the 1 icon are trademarks or registered trademarks of Exxon Mobil Corporation or one of its subsidiaries. Other trademarks shown are property of their respective owners. All rights reserved.

**CALL FOR PRICING FOR ALL PRODUCTS**

## Mobil 1™ Advanced Full Synthetic Motor Oil

- Keeps your engine running like new for longer.\*
- Protects for 15,000 miles – guaranteed.\*\*
- Helps extend engine life, even in severe conditions.
- Contains additives to help fight sludge.

Mobil 1 0W-16 5 QT	124322	Mobil 1 0W-16 1 QT	124321
Mobil 1 0W-20 5 QT	124185	Mobil 1 0W-20 1 QT	124184
Mobil 1 0W-30 5 QT	120761	Mobil 1 0W-30 1 QT	112746
Mobil 1 10W-30 3X 5 QT	122326	Mobil 1 10W-30 1 QT	122319
Mobil 1 5W-30 5 QT	124317	Mobil 1 5W-20 1 QT	103008
Mobil 1 5W-20 5 QT	120763	Mobil 1 5W-30 1 QT	124315



\*Vs. GF-6 Mobil 1™ motor oil ODI. \*\*Protects for 15,000 miles or 1 year, whichever comes first.

© 2026 ExxonMobil. Mobil, Mobil 1, and the 1 icon are trademarks or registered trademarks of Exxon Mobil Corporation or one of its subsidiaries. Other trademarks shown are property of their respective owners. All rights reserved.

### Full Synthetic Motor Oil

1 qt.

MOB 125197	0W20
MOB 125196	5W20
MOB 125195	5W30



### European Car Formula Advanced Full Synthetic Motor Oil

1 qt.

MOB 112628	0W40
MOB 126232	5W40

5 qt.

MOB 120760	0W40
MOB 126231	5W40



### Advanced Full Synthetic Motor Oil

1 qt.

MOB 103008	5W20
MOB 124315	5W30
MOB 122319	10W30

5 qt.

MOB 120763	5W20
MOB 124317	5W30
MOB 122326	10W30



### Turbo Diesel Truck Full Synthetic Motor Oil

1 qt.

5W40
MOB 122253

1 gal.
5W40
MOB 127097



### Advanced Fuel Economy Full Synthetic Motor Oil

1 qt.

0W8
MOB 127876

5 qt.

0W8
MOB 127857



### ESP Full Synthetic Motor Oil

1 qt.

MOB 127568	5W30
MOB 125386	0W20
MOB 124547	0W30
MOB 127918	0W40

5 qt.

MOB 126609	0W30
MOB 127706	0W20
MOB 127513	5W30



## CALL FOR PRICING FOR ALL PRODUCTS

LIMITED TIME OFFER JUNE-JULY

Get a **FREE** branded oil rack\* when you buy **TWELVE EIGHT** 6-gal Boxxes of Mobil 1™ motor oil.



127423	MOBIL 1 0W16 BOXX 6USG/22.71L
124119	MOBIL 1 0W20 BOXX 6USG/22.71L
124124	MOBIL 1 5W20 BOXX 6USG/22.71L
124128	MOBIL 1 5W30 BOXX 6USG/22.71L
124121	MOBIL 1 FS 0W40 BOXX 6USG/22.71L

\*Offer valid: 6/1/26–7/31/26. While supplies last. Terms and conditions apply. Purchase must be on one invoice. Cannot submit same invoice for multiple Mobil 1 offers. Imagery of prize is for illustration purposes only. Prize may vary.

Scan or visit  
mobilpromotions.com/NAPAInstaller  
to redeem.



© 2026 ExxonMobil. Mobil, Mobil 1, and the 1 icon are trademarks or registered trademarks of Exxon Mobil Corporation or one of its subsidiaries. Other trademarks shown are property of their respective owners. All rights reserved.

### Truck & SUV Full Synthetic Motor Oil

1 qt.

MOB 124592	0W20
MOB 124574	5W20
MOB 124595	5W30

5 qt.

MOB 124593	0W20
MOB 124575	5W20
MOB 124596	5W30



### High Mileage Full Synthetic Motor Oil

1 qt.

MOB 122535	0W20
MOB 120455	5W20
MOB 103767	5W30
MOB 103535	10W30
MOB 103536	10W40

5 qt.

MOB 122536	0W20
MOB 120768	5W20
MOB 120769	5W30
MOB 120770	10W30



### Extended Performance Full Synthetic Motor Oil

1 qt.

MOB 120926	0W20
MOB 102989	5W20
MOB 112627	5W30
MOB 102990	10W30

5 qt.

MOB 120903	0W20
MOB 120765	5W20
MOB 120766	5W30



### Extended Performance Full Synthetic High Mileage Motor Oil

1 qt.

MOB 123836	0W20
MOB 123839	5W20
MOB 123842	5W30

5 qt.

MOB 123837	0W20
MOB 123840	5W20
MOB 123843	5W30



# OIL & FLUIDS

## CALL FOR PRICING FOR ALL PRODUCTS

### Mobil 1™ Synthetic LV ATF HP

1 qt.  
MOB 124715



### SUPERCAR Full Synthetic Motor Oil

1 qt.  
MOB 126870 0W40  
MOB 127372 5W50



### VTwin

20W50  
1 qt.  
MOB 112630



### 1300 Super Diesel

1 gal.  
MOB 122485 10W30  
MOB 122492 15W40

6 gal.

MOB 124847 10W30  
MOB 124848 15W40



### Mobil Delvac Extreme Motor Oil

1 gal.  
MOB 122454 10W30  
MOB 122448 15W40



### 1 ESP Motor Oil Heavy Duty Diesel

1 gal.  
5W40  
MOB 127863



### Full Synthetic Motor Oil

5 qt.  
MOB 125198 5W30  
MOB 125199 5W20  
MOB 125200 0W20

6 gal.

MOB 127693 0W20  
MOB 128414 5W20  
MOB 128421 5W30



### Synthetic Automatic Transmission Fluid

1 gal.  
MOB 122062



### Tractor Hydraulic Fluid

5 gal.  
MOB 124788



CALL FOR PRICING FOR ALL PRODUCTS

## NAPA Premium Performance Motor Oil

NOL 75050	Premium Performance Motor Oil	1 qt.	5W30
NOL 75100	Premium Performance Motor Oil	1 qt.	10W40
NOL 75115	Premium Performance Non-Detergent Lubricating Oil	1 qt.	30W
NOL 75150	Premium Performance Synthetic Blend SAE Motor Oil	1 qt.	5W20
NOL 75130	Premium Performance SAE Motor Oil	1 qt.	10W30
NOL 75140	Premium Performance SAE Motor Oil	1 qt.	20W50
NOL 75135	Premium Performance Motor Oil	5 qt.	10W30
NOL 75055	Premium Performance Motor Oil	5 qt.	5W30
NOL 75105	Premium Performance Motor Oil	5 qt.	10W40
NOL 75155	Premium Performance Synthetic Blend Motor Oil	5 qt.	5W20
NOL 869864	Premium Performance Motor Oil	Bay Box	5W20
NOL 869933	Premium Performance Motor Oil	Bay Box	5W30
NOL 869934	Premium Performance Motor Oil	Bay Box	10W30
NOL 75053	Premium Performance Motor Oil	55 gal.	5W30
NOL 75134	Premium Performance Motor Oil	55 gal.	10W30
NOL 75154	Premium Performance Motor Oil	55 gal.	5W20
NOL 75104	Premium Performance Motor Oil	55 gal.	10W40



### NAPA® High Mileage Motor Oil

1 qt.

NOL 75340	5W20
NOL 75330	5W30
NOL 75300	10W30
NOL 75310	10W40

5 qt.

20W50  
NOL 75320

5 qt.

NOL 75345	5W20
NOL 75335	5W30
NOL 75305	10W30
NOL 75315	10W40



### NAPA® Full Synthetic Motor Oil

5 qt.

NOL 75541	0W20
NOL 75501	10W30
NOL 75531	5W20
NOL 75521	5W30
NOL 905304	0W16



### NAPA® Full Synthetic High Mileage Motor Oil

5 qt.

NOL 883595	10W30
NOL 883586	5W20
NOL 883575	5W30



### NAPA® High Mileage Motor Oil Bay Box

1 qt.

NOL 869952	5W20
NOL 869956	5W30
NOL 869935	10W30



### NAPA® Premium Performance Motor Oil

55 gal.  
20W50  
NOL 75144



# OIL & FLUIDS

**CALL FOR PRICING FOR ALL PRODUCTS**

## NAPA® Heavy Duty Diesel Engine Oil

1 gal.  
15W40  
NOL 75122

5 gal.  
15W40  
NOL 75121

55 gal.  
15W40  
NOL 75128



## NAPA® Motor Oil Conventional

5 gal.  
30W  
NOL 75126

5 gal.  
40W  
NOL 75118



## NAPA® Heavy Duty Diesel Engine Oil Bay Box

15W40  
NOL 869974

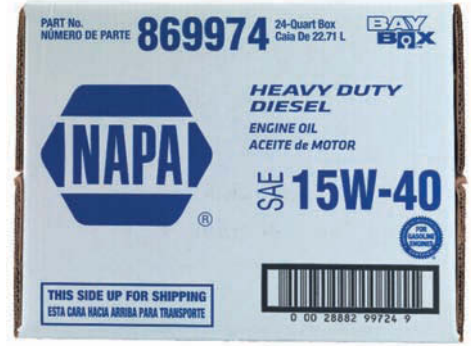

## NAPA® Universal Fleet Plus Motor Oil

1qt.  
15W40  
NOL 75123

## NAPA Premium Performance Conventional Motor Oil

1 qt.  
SAE30  
NOL 75110

1 qt.  
SAE40  
NOL 75120



## NAPA® Fleet Heavy Duty Diesel Motor Oil Full Synthetic

6 gal.  
5W40  
NOL 892056

## NAPA® Heavy Duty Motor Oil Heavy Duty Diesel

55 gal.  
5W40  
NOL 895046



## CALL FOR PRICING FOR ALL PRODUCTS

### NAPA® Heavy Duty Diesel Universal Fleet Plus Synthetic Blend Motor Oil

1 gal.  
10W30  
NOL 891953



### NAPA® Heavy Duty Diesel Universal Fleet Plus Full Synthetic Motor Oil

1 gal.  
5W40  
NOL 891939



### NAPA® Heavy Duty Universal Fleet Plus Engine Oil

2.5 gal.  
15W40  
NOL 904819



### NAPA® Universal Fleet Plus Motor Oil Conventional Heavy Duty Diesel

55 gal.

NOL 75127 30W  
NOL 75119 40W



## NAPA Premium Performance Automatic Transmission Fluid



NOL 75200	Premium Performance Dexron III / Mercon Automatic Transmission Fluid	1 qt.	NOL 75206	Premium Performance ATF+4 Automatic Transmission Fluid	1 qt.
NOL 75205	Premium Performance Type FA Automatic Transmission Fluid	1 qt.	NOL 914258	Premium Performance Automatic Transmission Fluid	1 gal.
NOL 75208	Premium Performance Dexron VI Automatic Transmission Fluid	1 qt.	NOL 914261	Multivehicle Automatic Transmission Fluid	1 gal.
NOL 914260	Multivehicle Automatic Transmission Fluid	1 qt.	NOL 75203	Dexron III / Mercon Automatic Transmission Fluid	5 gal.
NOL 914257	CVT Automatic Transmission Fluid	1 qt.	NOL 869973	Dexron III / Mercon Automatic Transmission Fluid	6 gal.
NOL 75207	Premium Performance Mercon V Automatic Transmission Fluid	1 qt.	NOL 891342	Multi-Vehicle Automatic Transmission Fluid	6 gal.
			NOL 75204	Dexron III / Mercon Automatic Transmission Fluid	55 gal.

# OIL & FLUIDS

## CALL FOR PRICING FOR ALL PRODUCTS

**Valvoline™ Premium Blue SAE Heavy Duty Engine Oil**  
1 gal.



VAL 773780	SAE Engine Oil	15W40
VAL 818289	Synthetic Blend	10W30
VAL 774038	Pr/Blue Xtr	5W40

**Valvoline™ All Terrain Motor Oil Heavy Duty Engine Oil**  
15W40  
1 gal.  
VAL 894015



**Valvoline™ Advanced Full Synthetic Motor Oil**  
5 qt.

VAL 878399	0W16
VAL 881147	5W20
VAL 881150	0W20
VAL 881164	5W30
VAL 881165	10W30



**Valvoline™ Full Synthetic High Mileage With MaxLife™ Motor Oil**  
5 qt.

VAL 881169	5W30
VAL 881170	10W30
VAL 881171	5W20



**Valvoline™ Extended Protection Motor Oil Full Synthetic**  
5 qt.

VAL 891670	5W30
VAL 891672	5W20
VAL 891674	0W16



**Valvoline™ Full Synthetic Hybrid Vehicle Motor Oil**  
0W20  
5 qt.  
VAL 898664



**Valvoline™ Restore & Protect Full Synthetic Motor Oil**  
5 qt.

VAL 904538	0W20
VAL 904562	5W20
VAL 904566	5W30



**Valvoline™ Full Synthetic European Motor Oil**  
5W40  
5 qt.  
VAL 881166



**Valvoline™ Extended Protection High Mileage Full Synthetic Motor Oil**  
5 qt.

VAL 899385	0W20
VAL 899387	5W20
VAL 899391	5W30



**Valvoline™ Full Synthetic European Motor Oil**  
0W40  
5 qt.  
VAL 881155



**Valvoline™ Premium Blue Motor Oil Heavy Duty Engine Oil**  
15W40

VAL 881173	15W40	2.5 gal.
VAL 891025	15W40	5 gal.
VAL 891005	15W40	5 gal.
VAL 891015	10W30	5 gal.
VAL 884940	5W40	5 gal.
VAL 891011	15W40	55 gal.
VAL 891013	10W30	55 gal.
VAL 70516	5W40	55 gal.



**Valvoline™ All Terrain Motor Oil Heavy Duty Engine Oil**  
10W40  
5 gal.  
VAL 894069



## CALL FOR PRICING FOR ALL PRODUCTS



### Buy 6 ePODS, Get a free dispenser

Excluding GTX Ultra Clean and GTX 10W-30 products.

Maximum Oil Usage Gravity-fed design ensures you use every last drop.

Efficient Inventory Management. Innovative dispensing system allows you to carry 4 viscosity grades in the same footprint of a drum; translucent bottle helps prevent out of stocks.

Premium look for Professionals. Fully integrated design with zero cross contamination.

\*ePODS dispensing kit includes one rack, one dispenser and four MAXFLOW pitchers. Contact your local NAPA Representative to order the no cost ePods Dispenser.

\*1 Dispenser Per Shop



CAS 15AFB3	GTX® High Mileage Synthetic Blend Epod Motor Oil	5W30	5 gal.
CAS 15AFB4	GTX® High Mileage Synthetic Blend Epod Motor Oil	5W20	5 gal.
CAS 15AFB5	GTX® High Mileage Synthetic Blend Epod Motor Oil	10W30	5 gal.
CAS 15E6DC	GTX® Full Synthetic Epod Motor Oil	5W30	5 gal.
CAS 15E726	GTX® Full Synthetic Epod Motor Oil	0W20	5 gal.
CAS 15E72F	GTX® Full Synthetic Epod Motor Oil	5W20	5 gal.
CAS 15BA87	EDGE® Euro Car A3/B4 Full Synthetic Epod Motor Oil	0W40	5 gal.
CAS 15D939	EDGE® Euro Car A3/B4 Full Synthetic Epod Motor Oil	5W40	5 gal.
CAS 15E895	EDGE® Euro Car K Spec Full Synthetic Epod Motor Oil	5W30	5 gal.
CAS 15AFB7	EDGE® Full Synthetic Epod Motor Oil	0W20	5 gal.
CAS 15AFB8	EDGE® Full Synthetic Epod Motor Oil	5W20	5 gal.
CAS 15AFB9	EDGE® Full Synthetic Epod Motor Oil	5W30	5 gal.
CAS 15C86A	EDGE® Full Synthetic Epod Motor Oil	0W16	5 gal.
CAS 1606CB	EDGE® Euro LL Epod Motor Oil	0W30	5 gal.
CAS 1606CC	EDGE® Euro A3/B4 Epod Motor Oil	0W30	5 gal.
CAS 15B25D	EDGE® High Mileage Full Synthetic Epod Motor Oil	5W30	5 gal.

Ask your local sales rep about Castrol drums

### Castrol® GTX® Oil

5 qt.

#### GTX® Motor Oil

1 qt.

CAS 122 20W50

CAS 091	5W20
CAS 096	5W30
CAS 093	10W30
CAS 094	10W40
CAS 095	20W50

1 qt.

CAS 107	5W20
CAS 082	5W30
CAS 092	10W30
CAS 112	10W40



### GTX® High Mileage Motor Oil

1 qt.

CAS 148	5W20
CAS 440	5W30
CAS 450	10W30
CAS 460	10W40
CAS 470	20W50

5 qt.

CAS 100	5W20
CAS 102	5W30
CAS 110	10W30
CAS 111	10W40



### GTX® Full Synthetic Motor Oil

1 qt.

CAS 15E728	0W20
CAS 15E72D	5W20
CAS 15E6E2	5W30

5 qt.

CAS 15E725	0W20
CAS 15E72E	5W20
CAS 15E6DE	5W30



### Castrol® EDGE® Oil

#### EDGE® High Mileage Full Synthetic Motor Oil

1 qt.

CAS 15D47C	0W20
CAS 06122	5W20
CAS 06129	10W30
CAS 06171	10W40
CAS 06128	5W30

5 qt.

CAS 15B0D2	0W20
CAS 15906D	5W20
CAS 15906E	5W30
CAS 15906F	10W30



#### EDGE® Full Synthetic Motor Oil

1 qt.

CAS 011	0W20
CAS 15D32F	0W16
CAS 247	5W20
CAS 248	5W30
CAS 250	5W50
CAS 245	10W30
CAS 246	10W40

5 qt.

CAS 3081	10W30
CAS 083	5W20
CAS 084	5W30
CAS 3124	0W20



#### EDGE® Euro Advanced Full Synthetic Motor Oil - 1 qt.

CAS 249	5W40 A3/B4
CAS 518	0W40 A3/B4
CAS 15DA06	0W30
CAS 15F215	0W20
CAS 15E892	5W30

5 qt.

CAS 15E891	5W30
CAS 1606CD	0W30 A3/B4
CAS 3101	0W40
CAS 3247	5W40 A3/B4
CAS 16107D	0W20

CAS 161B1B	EDGE 0W8	1 qt.
CAS 161B1C	EDGE 0W8	5 qt.
CAS 16108A	EDGE EURO 0W30LL	5 qt.
CAS 1610CD	EDGE EURO CAR 0W20 M	5 gal.

#### EDGE® Euro Car Full Synthetic Motor Oil

0W20

1 qt.

CAS 16107F



**CALL FOR PRICING FOR ALL PRODUCTS**



## Cheers to Performance

Spend \$1,000 on Castrol full-synthetic products\*, get a

**Castrol Whiskey Glass Set\*\***

Includes:

- 2 whiskey glasses
- 2 black leatherette coasters
- 6 whiskey stones



**Scan here to redeem**

Terms and Conditions apply. Restrictions apply.

\* On one invoice.  
\*\* Offer valid from 6/1/26 – 7/31/26.

### CRB® Multi Synthetic Blend Motor Oil

1 gal.  
15W40  
CAS 155



### GTX® Diesel CK-4 Motor Oil

1 gal.  
15W40  
CAS 849



### Vecton Part Synthetic CK-4 Motor Oil

1 gal.  
15W40  
CAS 156



### Castrol® TranSynd 668 Synthetic Transmission Fluid

1 gal.  
CAS 15E2E1



### Castrol® TranSynd 668 Synthetic Transmission Fluid

5 gal.  
CAS 15E2E0



### Castrol® TranSynd 668 Synthetic Transmission Fluid

55 gal.  
CAS 15E2DF



# OIL & FLUIDS

## CALL FOR PRICING FOR ALL PRODUCTS



### High Performance Full Synthetic Motor Oil

RPO 01016	OW16	RPO 01530	5W30
RPO 01020	OW20	RPO 01540	5W40
RPO 01520	5W20	RPO 011484	OW40
RPO 01130	10W30		



### Max ATF Automatic Transmission Fluid

1 qt.  
RPO 01320

6 gal.  
RPO 61320



### Synchronax Manual Transmission Fluid

1 qt.  
RPO 01512



### Max-Gear Oil

1 qt.  
75W90  
RPO 01300

1 qt.  
75W140  
RPO 01301



### Duralec® Super™ Diesel Motor Oil

1 gal.  
RPO 04154 15W40  
RPO 83540 5W40



### Duralec® Ultra Diesel Motor Oil

1 gal.  
RPO 83456 10W30  
RPO 83561 15W40



### High Performance Motor Oil

5 qt.  
RPO 51020 OW20  
RPO 51130 10W30  
RPO 51520 5W20  
RPO 51530 5W30  
RPO 51016 SAE OW16



### High Performance Synthetic Motor Oil

6 gal.  
RPO 60016 OW16  
RPO 60520 5W20  
RPO 60530 5W30  
RPO 60020 OW20

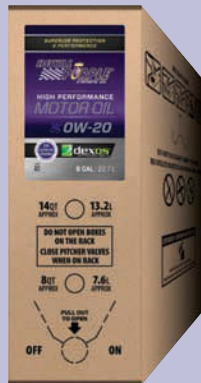

### High Performance Euro Formula Synthetic Motor Oil

6 gal.  
RPO 60040 OW40  
RPO 60540 5W40



### Q2 INSTALLER INCENTIVE

ACTUAL PRODUCT MAY VARY



## LOAD UP. ROLL OUT.

**ROYAL PURPLE INSTALLERS GET A FREE ROYAL PURPLE FOLDABLE HEAVY DUTY UTILITY CART**

PROMOTION DATES | APRIL 1 — JUNE 30, 2026

#### HOW THE PROMOTION WORKS

Get a Royal Purple Foldable Heavy Duty Utility Cart when you purchase 15 cases or more, or an equivalent volume in alternative packages, of any Royal Purple lubricant or grease product(s) during the promotion period (excludes chemicals). See terms and conditions for additional details.

#### HOW TO GET YOUR FOLDABLE UTILITY CART

- Filing a claim is easy. Just take a photo or scan of the invoice clearly documenting your qualifying 15 case purchase during the Promotion Period. 15 case purchase must be made on single invoice.
- Go to: [Installer.RoyalPurplePromos.com](http://Installer.RoyalPurplePromos.com). Fill in the required information on the online claim form. Upload a scan or photo of your invoice.
- Click Submit.
- Your claim will be validated and processed, and your Foldable Heavy Duty Utility Cart will be automatically shipped to the address provided in the online claim form within 4 weeks of submission.
- Claim deadline: July 15, 2026

SEE PROMOTIONAL SUBJECT TO CHANGE

## CALL FOR PRICING FOR ALL PRODUCTS

### Pennzoil® Full Synthetic Motor Oil

1 qt.

PEN 550058594	0W20
PEN 550058603	10W30
PEN 550058597	5W20
PEN 550058600	5W30

5 qt.

PEN 550058596	0W20
PEN 550058604	10W30
PEN 550058599	5W20
PEN 550058602	5W30



### Pennzoil® High Mileage Full Synthetic Motor Oil

1 qt.

PEN 550069989	0W20
PEN 550069991	5W20
PEN 550069993	5W30

5 qt.

PEN 550069988	0W20
PEN 550069990	5W20
PEN 550069992	5W30



### Pennzoil® High Mileage Vehicle Motor Oil

1 qt.

PEN 550022818	5W20
PEN 550022838	5W30
PEN 550022812	10W30
PEN 550022829	10W40

5 qt.

PEN 550045203	5W20
PEN 550045205	10W30
PEN 550045218	5W30



### Platinum Full Synthetic Motor Oil

1 qt.

PEN 550049266	0W16
PEN 550036541	0W20
PEN 550022686	5W20
PEN 550022689	5W30
PEN 550022687	10W30

### Platinum Full Synthetic High Mileage Motor Oil

1 qt.

PEN 550046634	0W20
PEN 550042724	5W20
PEN 550042728	5W30
PEN 550043951	10W30

### Platinum/Euro Full Synthetic Motor Oil

1 qt.

PEN 550051126	5W30
PEN 550051120	5W40

### Platinum High Mileage Full Synthetic Motor Oil

5 qt.

PEN 550045196	5W20
PEN 550045195	5W30
PEN 550046636	0W20
PEN 550045274	10W30

### Platinum Full Synthetic Motor Oil

5 qt.

PEN 550046127	0W20
PEN 550046122	5W20
PEN 550046126	5W30
PEN 550046205	10W30
PEN 550049263	0W16



### Pennzoil® Ultra Platinum Full Synthetic Motor Oil

1 qt.

PEN 550039860	0W20
PEN 550040856	0W40
PEN 550040863	5W20
PEN 550040865	5W30

5 qt.

PEN 550045202	5W20
PEN 550045201	5W30



### Pennzoil® Euro L Motor Oil

5 qt.

5W30

PEN 550051123





# Introducing Shell Ecobox™



**Pennzoil Ultra Platinum™**  
5W-30 | 550040843



**Pennzoil Platinum®**  
0W-16 | 550048977



**Pennzoil Platinum®**  
0W-20 | 550036473



**Shell Rotella® T6**  
5W-40 | 550046218

## Other Available Products

SKU	Product
550045150	Shell Rotella® T4 Triple Protection® 15W-40 (CK-4)
550046218	Shell Rotella® T6 5W-40 (CK-4)
550045149	Shell Rotella® T4 Triple Protection® 10W-30 (CK-4)
550040843	Pennzoil Ultra Platinum™ 5W-30 Full Synthetic Motor Oil (SP/GF-6A)
550022685	Pennzoil Platinum® 5W-20 Full Synthetic Motor Oil (SP/GF-6A dexos1)
550022688	Pennzoil Platinum® 5W-30 Full Synthetic Motor Oil (SP/GF-6A dexos1)
550048977	Pennzoil Platinum® 0W-16 Full Synthetic Motor Oil (SP/GF-6B)
550036473	Pennzoil Platinum® 0W-20 Full Synthetic Motor Oil (SP/GF-6A dexos1)
550051122	Pennzoil® Euro L SAE 5W-30 Fully Synthetic Motor Oil (SN C3 + OEMs - 2019)
550051110	Pennzoil Platinum® Euro SAE 0W-40 Full Synthetic Motor Oil (SP + OEMs)



# OIL & FLUIDS

## CALL FOR PRICING FOR ALL PRODUCTS

### Shell Rotella® T4 Triple Protection Motor Oil

SHE 550045144	10W30	1 gal.	SHE 550045128	15W40	5 gal.
SHE 550045126	15W40	1 gal.	SHE 550045137	10W30	55 gal.
SHE 550045127	15W40	2.5 gal.	SHE 550045148	15W40	55 gal.



### Shell ROTELLA® T1 Straight Grade Conventional Motor Oil

SHE 550054449	SAE 30	1 gal.	SHE 550054448	SAE 30	5 gal.
SHE 550054466	SAE 40	1 gal.	SHE 550054465	SAE 40	5 gal.

### Shell Rotella® T5 Synthetic Blend Motor Oil

SHE 550045130	10W30	1 gal.	SHE 550045131	10W30	55 gal.
SHE 550045348	15W40	1 gal.	SHE 550046214	15W40	55 gal.
SHE 550046254	10W30	1 gal.			



### Shell ROTELLA® T6 Synthetic Motor Oil

SHE 550046251	5W30	1 gal.	SHE 550046215	5W40	2.5 gal.
SHE 550045347	5W40	1 gal.	SHE 550046217	5W40	5 gal.
SHE 550050467	15W40	1 gal.	SHE 550062921	15W40	5 gal.
SHE 550069698	10W30	1 gal.	SHE 550046219	5W40	55 gal.

### Shell Spirax S6 Automatic Transmission Fluid ATF A668

1 gal.  
SHE 550062008

5 gal. SHE 550062007  
55 gal. SHE 550062005



### Shell ROTELLA® Heavy Duty Tractor Transmission Fluid

5 gal.  
SHE 550039811



# OIL & FLUIDS

CALL FOR PRICING FOR ALL PRODUCTS

Quaker State®  
Advanced Durability  
1 qt.

OO 550034964	10W40
OO 550035082	5W20
OO 550035170	10W30
OO 550035180	5W30
OO 550035190	SAE 30



# PROVEN ON THE RACETRACK.

## UNLEASHED ON THE STREETS.

**Top Tec 4200 SAE 5W-30 New Generation**  
5 l, Part no. LM 2011

**Leichtlauf High Tech SAE 5W-40**  
5 l, Part no. LM 2332



# OIL & FLUIDS

CALL FOR PRICING FOR ALL PRODUCTS



SAVE UP TO 58%



AIC 30040095750	ATF J-Idemitsu	1 qt.	AIC 30041103750	CVT Type TLS FE Transmission Fluid for Toyota CVTS	1 qt.
AIC 30040093750	ATF Type TLS (T-IV) Auto Trans Fluid for Toyota/Lexus/Scion	1 qt.	AIC 30041113750	Automatic Transmission Fluid CVTF TYPE-SB2	1 qt.
AIC 30040099750	ATF Type HP Automatic Transmission Fluid for Subaru	1 qt.	AIC 30040093953	ATF Type TLS (T-IV) Auto Trans Fluid for Toyota/Lexus/Scion	5 qt.
AIC 30040097750	ATF Type HK (SP-III) Automatic Trans. Fluid for Hyundai/Kia	1 qt.	AIC 30040096953	ATF Type TLS-LV (WS) Auto.Trans.Fluid for Toyota/Lexus/Scion	5 qt.
AIC 30040096750	ATF Type TLS-LV (WS) Auto.Trans.Fluid for Toyota, Lexus,Scion	1 qt.	AIC 30040099953	ATF Type HP Automatic Transmission Fluid for Subaru	5 qt.
AIC 30040090750	ATF Type H-Plus Automatic Transmission Fluid for Honda, Acura	1 qt.	AIC 30040090953	ATF Type H-Plus Automatic Transmission Fluid for Honda/Acura	5 qt.
AIC 30040092750	ATF Type M (M3/M5) Automatic Transmission Fluid for Ford/Mazda	1 qt.	AIC 30040101953	ATF Type S Automatic Transmission Fluid for Nissan Matic S/J/D	5 qt.
AIC 30040091750	CVT Type N (NS-2) Transmission Fluid for Nissan	1 qt.	AIC 30040091953	CVT Type N (NS-2) Transmission Fluid for Nissan	5 qt.
AIC 30040100750	ATF Type HK4 Automatic Transmission Fluid for Hyundai/Kia	1 qt.	AIC 30040097953	ATF Type HK (SP-III) Automatic Trans. Fluid for Hyundai/Kia	5 qt.
AIC 30040101750	ATF Type S Automatic Transmission Fluid for Nissan Matic S/J/D	1 qt.	AIC 30041114953	Automatic Transmission Fluid CVTF TYPE-H2	5 qt.
AIC 30041114750	Automatic Transmission Fluid CVTF TYPE-H2	1 qt.	AIC 30041113953	Automatic Transmission Fluid CVTF TYPE-SB2	5 qt.
AIC 30041102750	CVT Type N3 Transmission Fluid for Nissan	1 qt.			

**QUICKSILVER**  
Marine Parts & Accessories

SAVE UP TO 24%



NCB 928M0229784	Premium 2-Cycle Oil	16 oz.	NCB 928M0222065	SAE90 Marine High Performance Gear Lube	32 oz.
NCB 92858020Q01	TC W3 Valmar Marine 2-Cycle Oil	16 oz.	NCB 92858027Q01	Premium Plus TC W3 Valmar Marine 2-Cycle Oil	1 gal.
NCB 928M0078619	Marine 4-Stroke Motor Oil 25W40 Synthetic Blend	1 qt.	NCB 92858022Q01	TC W3 Valmar Marine 2-Cycle Oil	1 gal.
NCB 92858064Q01	Hypoid 90 Marine High Performance Gear Lube	32 oz.	NCB 928M0229791	Premium 2-Cycle Oil	1 gal.

Pricing Valid as of 6/1/2026 and expires 6/30/2026 but is subject to change based on external factors. Any changes to pricing will be disclosed prior to purchase.

## CALL FOR PRICING FOR ALL PRODUCTS



### 400 XLE SAE Synthetic Blend Motor Oil

1 gal.  
15W40  
CHV GAL15W40SB



### 400 XLE SAE Synthetic Blend Motor Oil

1 gal.  
10W30  
CHV GAL10W30



### 400 LE Motor Oil

1 gal.  
5W40  
CHV GAL5W40



### 400 LE Motor Oil

3 gal.  
15W40  
CHV 3GAL15W40SB



### 400 XLE SAE Synthetic Blend Motor Oil

1 gal.  
15W40  
CHV 5GAL15W40SB



# ANTIFREEZE

## THE RIGHT ANTIFREEZE SOLUTION FOR ANY VEHICLE'S COOLING SYSTEM



**EXTENDED LIFE ORANGE  
DEX-COOL COMPATIBLE  
RTU1DEX  
\$8.69**



**EXTENDED LIFE  
ALL MAKES ALL MODELS  
RTU1EXT  
\$8.49**



**CONVENTIONAL  
GREEN  
RTU1GAL  
\$8.49**

## NAPA® HEAVY DUTY ANTIFREEZE + COOLANT



**OUTSTANDING ENGINE PROTECTION FOR ALL HEAVY-DUTY COOLING SYSTEMS**

**SCA PRECHARGED HEAVY DUTY HDRTU1GAL \$8.69**

**READY TO USE HDRTU55GAL \$389.99**



## STOCK UP, VOLUME BUY UP TO 35% OFF

**NAPA® ANTIFREEZE + COOLANT • 55 GALLON DRUMS INCLUDING: RTU55DEX, RTU55EXT, RTU55GAL**



**AS LOW AS \$9.49**  
/each

**Zerex™ Cooling System Antifreeze/Coolant**  
1 gal.

ZRX ZXPGRU1	HD Green Ready to Use	\$9.49
ZRX 846437	HD Yellow Ready to Use	\$11.99
ZRX 895622	HD Red Ready to Use	\$11.99



**\$9.79**  
/each

**Zerex™ Cooling System Antifreeze Coolant Ready to Use**  
1 gal.  
ZRX 841943



**AS LOW AS \$11.99**  
/each

**Zerex™ HD Extended Life Antifreeze/Coolant**  
1 gal.

ZRX ZXEDRU1	Ready to Use	\$11.99
ZRX ZXED1	Concentrate	\$15.99
ZRX 846439	Nitrite Free Concentrate	\$16.99



**AS LOW AS \$559.99**  
/each

**Zerex Cooling System Antifreeze Coolant**  
55 gal.

ZRX 846438	Nitrate-Free Ready to Use	\$559.99
ZRX ZXEDRU2	Extended Life Ready to Use	\$559.99
ZRX ZXED2	Extended Life Concentrate	\$759.99



# ANTIFREEZE

**\$8<sup>99</sup>**  
/each

**ShellZone Cooling System Antifreeze Ready To Use**

1 gal.  
SHE 550062811



**\$10<sup>99</sup>**  
/each

**Shell ROTELLA® Cooling System Antifreeze Ready To Use**

1 gal.  
SHE 9404206021



**\$11<sup>99</sup>**  
/each

**Shell ROTELLA® Cooling System Antifreeze Ready To Use**

1 gal.  
SHE 550041810



**\$14<sup>99</sup>**  
/each

Concentrate  
SHE 9404106021

**\$15<sup>49</sup>**  
/each

Concentrate  
SHE 550041812

**AS LOW AS \$8<sup>39</sup>**  
/each

**Zerex™ Cooling System Antifreeze Coolant**

ZRX ZXRU1	Ready to Use 1 gal.	<b>\$8.39</b>
ZRX ZXRU2	Ready to Use 55 gal.	<b>\$389.99</b>
ZRX ZX001	Concentrate 1 gal.	<b>\$12.49</b>
ZRX ZX002	Concentrate 55 gal.	<b>\$599.99</b>



**AS LOW AS \$9<sup>69</sup>**  
/each

**Zerex™ Dex-Cool Antifreeze/Coolant**

ZRX ZXELRU1	Ready to Use 1 gal.	<b>\$9.69</b>
ZRX ZXELRU2	Ready to Use 55 gal.	<b>\$439.99</b>
ZRX ZXEL1	Concentrate 1 gal.	<b>\$13.99</b>
ZRX ZXEL2	Concentrate 55 gal.	<b>\$649.99</b>



**AS LOW AS \$10<sup>49</sup>**  
/each

**Zerex™ G05 Antifreeze/ Coolant**

ZRX ZXG05RU1	Ready to Use 1 gal.	<b>\$10.49</b>
ZRX ZXG05RU2	Ready to Use 55 gal.	<b>\$489.99</b>
ZRX ZXG051	Concentrate 1 gal.	<b>\$15.99</b>
ZRX ZXG052	Concentrate 55 gal.	<b>\$749.99</b>



**\$10<sup>99</sup>**  
/each

**Zerex™ American Vehicle Cooling System Antifreeze**

Ready To Use  
1 gal.  
ZRX 888374



**AS LOW AS \$11<sup>19</sup>**  
/each

**Zerex™ Asian Vehicle Antifreeze/Coolant Ready to Use**

ZRX 675130	Red 1 gal.	<b>\$11.19</b>
ZRX 861398	Blue 1 gal.	<b>\$11.19</b>
ZRX 888418	Green 1 gal.	<b>\$11.19</b>
ZRX 675129	Red 55 gal.	<b>\$529.99</b>



**\$11<sup>99</sup>**  
/each

**Zerex™ Hybrid Vehicle Antifreeze 50/50**

1 gal.  
ZRX 898406



**\$12<sup>99</sup>**  
/each

**Zerex™ American Vehicle Concentrate Antifreeze & Coolant**

1 gal.  
ZRX 909683



**AS LOW AS \$12<sup>99</sup>**  
/each

**Zerex™ G48 Antifreeze/Coolant**

ZRX 859537	Ready to Use 1 gal.	<b>\$12.99</b>
ZRX 861583	Concentrate 1 gal.	<b>\$17.99</b>
ZRX ZXG482	Concentrate 55 gal.	<b>\$849.99</b>



**\$13<sup>49</sup>**  
/each

**Zerex™ G30 Cooling System Antifreeze**

Ready To Use  
1 gal.  
ZRX 877981



**AS LOW AS \$13<sup>49</sup>**  
/each

**Zerex™ G40 Antifreeze/Coolant**

ZRX 861399	Ready to use 1 gal.	<b>\$13.49</b>
ZRX 861526	Concentrate 1 gal.	<b>\$18.49</b>
ZRX 691732	Concentrate 55 gal.	<b>\$879.99</b>



**\$15<sup>49</sup>**  
/each

**Zerex™ Cooling System Antifreeze**

ZRX 904683	HT-12 Pink
ZRX 904685	HT-12 Green



**\$15<sup>99</sup>**  
/each

**Zerex™ Asian Vehicle Antifreeze & Coolant Concentrate**

ZRX 910234	Red
ZRX 910236	Blue
ZRX 910238	Green



# GREASE & GEAR OIL

## CALL FOR PRICING FOR ALL PRODUCTS

### NAPA® High Temp Red Grease 50/14.

1 oz.  
NOL 914080



### NAPA® Premium Performance Multi-Purpose Wheel Bearing Grease

14 oz.  
NOL 75600



### NAPA® Premium Performance Multi-Purpose Wheel Bearing Grease

1 lb.  
NOL 75601



### NAPA® Premium Performance Multi-Purpose Wheel Bearing Grease

4 lb.  
NOL 75602



### Shell ROTELLA®

Tube/Cartridge  
14.1 oz.

SHE 550049923  
MP Multi-Purpose Lithium Grease  
SHE 550049924  
ET Extreme Temperature Tacky Grease

SHE 550049925  
HD Premium Heavy Duty Grease  
SHE 550049926  
SD Special Duty Moly Grease



SHE 550049923

SHE 550049924

SHE 550049925

SHE 550049926

### Valvoline™ Grease

VAL 70124	Crimson #2 Multi-Purpose Grease	14 oz.
VAL 70133	Cerulean #2 Multi-Purpose Grease	14 oz.
VAL 70112	Palladium #2 with Moly Multi-Purpose Grease	14 oz.
VAL 872117	Cobalt #2 Grease	14 oz.
VAL 985	Synpower Synthetic Grease	14 oz.
VAL 70122	Crimson #2 Multi-Purpose Grease	35 lbs.
VAL 70120	Crimson #2 Multi-Purpose Grease	120 lbs.



### Valvoline™ General Purpose EP Grease

VAL 609	14 oz.
VAL 606	35 lbs.
VAL 605	120 lbs.

### Valvoline™ Multi-Purpose Grease

VAL 615	14 oz.
VAL 614	1 lb.
VAL 616	4 lb.
VAL 612	35 lbs.
VAL 611	120 lbs.

### Valvoline™ Moly-Fortified Multi-Purpose Grease

14 oz.  
VAL 633



Pricing Valid as of 6/1/2026 and expires 6/30/2026 but is subject to change based on external factors. Any changes to pricing will be disclosed prior to purchase.

# GREASE & GEAR OIL

CALL FOR PRICING FOR ALL PRODUCTS



**VALVOLINE™  
FULL SYNTHETIC  
GEAR OIL**  
1 qt.

- FLEX FILL POUCH – EASY TO USE AND LESS WASTE
- EXCEPTIONAL HIGH AND LOW TEMPERATURE PROTECTION



## Valvoline® Gear Oil



VAL 825	High Performance Gear Oil	85W140	1 qt.
VAL 831	High Performance Gear Oil	80W90	1 qt.
VAL 820	High Performance Gear Oil	75W90	1 qt.
VAL 889785	Full Synthetic FlexFill Gear Oil	75W90	1 qt.
VAL 902146	Extended Protection Gear Oil	75W90	1 qt.
VAL 889787	Full Synthetic FlexFill Gear Oil	75W140	1 qt.
VAL 902150	Extended Protection Gear Oil	75W140	1 qt.
VAL 882505	Synpower Gear Oil	75W90	1 gal.
VAL 887344	Synpower Gear Oil	75W140	1 gal.
VAL 829	High Performance Gear Oil	85W140	5 gal.
VAL 838	High Performance Gear Oil	80W90	5 gal.
VAL 723856	Synpower Gear Oil	75W90	5 gal.
VAL 981	Synpower Gear Oil	75W140	5 gal.
VAL 836	High Performance Gear Oil	80W90	16 gal.



## Valvoline™ AGMA EP5/ISO 220 Gear Oil

5 gal.  
VAL 70016



## Valvoline™ Heavy Duty Gear Oil

5 gal.

VAL 700285M 75W90  
VAL 700475M 80W140

55 gal.  
75W90  
VAL 70026



# CHEMICALS & COMMODITIES

# WEITRON

SAVE UP TO **53%**



STARTING AT **\$869** /each

NFR W2458	R-1234yf Oil	8 oz.	<b>\$8.69</b>
NFR R1234YFCAN	Honeywell R-1234yf Refrigerant	8 oz.	<b>\$20.99</b>
NFR R1234YFCANUV	Honeywell R-1234yf Refrigerant With UV Dye	8 oz.	<b>\$23.49</b>
NFR W2459	R-1234yf Oil	1 qt.	<b>\$30.39</b>
NFR R1234YF10	R1234yf Refrigerant	10 lb.	<b>\$375.99</b>

NFR R1234YF10UV	Honeywell R-1234yf Uv Refrigerant Cylinder	10 lb.	<b>\$424.99</b>
NFR R1234YF25	Honeywell R-1234yf Refrigerant Cylinder	25 lb.	<b>\$899.99</b>
NFR R1234YF25UV	Honeywell R-1234yf UV Refrigerant Cylinder	25 lb.	<b>\$999.99</b>
NFR ZX3012SS	Weitron R-134a Refrigerant Self-Sealing Can	12 oz.	<b>Call For Pricing</b>
NFR ZX3030	Weitron R-134a Refrigerant Cylinder	30 lb.	<b>Call For Pricing</b>

WORK IT LIKE A PRO  
**BLASTER**

SAVE UP TO **43%**



NCB BLA150	R-134a Stop Leak Charge	3 oz.	<b>\$12.29</b>
NCB BLA405	R-134a Stop Leak Charge		<b>\$14.79</b>
NCB BLA451YFA	R-1234yf Recharge Hose w/ Smart Clips		<b>\$19.69</b>
NCB BLA606YF	R-1234yf Safe Seal	3 oz.	<b>\$23.29</b>
NCB BLA155	Triple Seal For R-134a	3 oz.	<b>\$23.49</b>
NCB BLA310	R-134a W/Stop Leak	12 oz.	<b>\$25.99</b>
NCB BLA151	R-1234yf Stop Leak	3 oz.	<b>\$34.79</b>

NCB BLA346A	R-134a Recharge Kit w/ Wrap Gauge Hose	16 oz.	<b>\$45.49</b>
NCB BLA611YF	R-1234yf Recharge Kit w/ Smart Clips	10 oz.	<b>\$55.99</b>
NCB BLA235D	R-134a Recharge Kit w/ Digital Gauge & Smart Clips	16 oz.	<b>\$57.99</b>
NCB BLA602YFD	R-1234yf W/Digital Gauge	10 oz.	<b>\$64.29</b>
NCB BLA610YFA	R-1234yf Recharge Kit w/ Analog Gauge & Smart Clips	12 oz.	<b>\$67.99</b>
NCB BLA608YFC	R-1234yf Recharge Kit w/ Digital Display and RFID Smart Chip	14 oz.	<b>\$92.79</b>

Pricing Valid as of 6/1/2026 and expires 6/30/2026 but is subject to change based on external factors. Any changes to pricing will be disclosed prior to purchase.

## THIS IS **NOT** THE CLASSIC WD-40® PRODUCT

### MEET OUR SPECIALIST LINE.

HEAVY-DUTY PRODUCTS FOR **HEAVY-DUTY WORK.**

**\$7.49**

Part# WD 300004  
**WD-40 SPECIALIST.  
PENETRANT**

Fast-acting formula breaks rust and corrosion that jam up parts and leaves behind a protective layer that prevents future corrosion.

**\$7.99**

Part# WD 30001  
**WD-40 SPECIALIST.  
WHITE LITHIUM GREASE**

Ideal for metal-to-metal applications that require heavy-duty lubrication and protection against rust and corrosion.

**\$6.99**

Part# WD 30001  
**WD-40 SPECIALIST.  
SILICONE**

Use on a variety of surfaces - metal, rubber, vinyl, plastic and more. Use on 100s of items like locks, chains, pulleys, hinges, valves, cables, etc.

METAL-TO-METAL APPLICATIONS

LOOSEN STUCK PARTS

RESISTS WATER



WD-40® Brand products (WD-40 Specialist®, WD-40® Multi-Use Product) do not contain ingredients at levels requiring California Prop 65 warnings, including benzene or toluene.

# Mac's

STARTING AT  
**\$3.19**  
/each



MAC 8700	Carb, Choke & Throttle Body Cleaner	12 oz.	<b>\$3.19</b>
MAC 4800	Brake Parts Cleaner Non-Chlorinated	13 oz.	<b>\$3.49</b>

MAC 4810	Brake Parts Cleaner Ultra Low V.O.C.	13 oz.	<b>\$3.99</b>
MAC 1370	Chain & Cable Lube	12.75 oz.	<b>\$5.69</b>

# CHEMICALS & COMMODITIES

STARTING AT  
\$4.29  
/each

SAVE  
UP TO  
48%

**BLASTER**  
WORK IT LIKE A PRO

**GUNK**



## BLASTER

NCB PB50	Multi-Purpose Lubricant	8 oz.	\$4.69
NCB 16BPTCAP	Battery Terminal Cleaner & Protector 2-in-1	11 oz.	\$4.99
NCB GR14CHTR	Tacky Red Grease	17 oz.	\$5.19
NCB 16LG	White Lithium Grease	11 oz.	\$5.99
NCB 16SL	Silicone Lubricant	11 oz.	\$5.99
NCB 16PBD5	PB B'laster Penetrant	11 oz.	\$6.79
NCB 5PWS	Parts Washer Solvent	5 gal.	\$90.99

## GUNK

NCB M715	Non-Chlorinated Brake Parts Cleaner	14 oz.	\$4.29
NCB M710	Non-Chlorinated Brake Parts Cleaner (50-State Compliant)	14 oz.	\$4.29
NCB M720	Chlorinated Brake Parts Cleaner	19 oz.	\$4.79
NCB FEB1	Engine Brite® Foamy Engine Cleaner	17 oz.	\$4.99
NCB EB1	Original Engine Degreaser	15 oz.	\$5.49
NCB M4815NC	Gunk Carb Medic	17 oz.	\$5.49
NCB FEB1CA	Engine Brite® Foamy Engine Cleaner (CA Approved)	17 oz.	\$5.49
NCB EB1CA	Original Engine Degreaser (CA Approved)	15 oz.	\$5.79
NCB EB232	Engine Cleaner/Degreaser - Multi-Surface	32 oz.	\$6.29

Pricing Valid as of 6/1/2026 and expires 6/30/2026 but is subject to change based on external factors.  
Any changes to pricing will be disclosed prior to purchase.

# CHEMICALS & COMMODITIES

## CRC Brakleen® #1 BRAKE PARTS CLEANER

**\$439**  
/each

**Brakleen® Non-Chlorinated  
Brake Parts Cleaner**

14 oz.

CRC 05050 50 State

CRC 05088 High Strength

CRC 05084 Low VOC



**\$459**  
/each

**Heavy Duty  
Silicone Lubricant**

19 oz.

CRC 05074



**\$499**  
/each

**Brakleen®  
Non-Flammable  
Brake Parts  
Cleaner**

19 oz.

CRC 05089



**\$389**  
/each

**Brakleen® Non-Chlorinated  
Brake Parts Cleaner Ultra  
Low VOC Complies w/  
SCAQMD Rule 1171**

14 oz.

CRC 05151

**\$889**  
/each

**Sta-Lube® Fluid Oil Pump**

1 gal.

SL SL4344



**\$939**  
/each

**Engine Star®  
Fogging Oil**

13 oz.

CRC 06068



**\$999**  
/each

**Heavy Duty  
Corrosion Inhibitor**

10 oz.

CRC 06026



**\$1449**  
/each

**GDI IVD® Intake  
Valve & Turbo Cleaner**

11 oz.

CRC 05319



**\$1449**  
/each

**Mildew Stain Remover**

19 oz.

CRC MK3732



**\$1849**  
/each

**On & Off Hull &  
Bottom Cleaner**

19 oz.

CRC MK2032



**\$4649**  
/each

**Sta-Lube®  
Multi-purpose  
Gear Oil**

API/GL-4I

SAE90W

1 gal.

SL SL24239



**STARTING AT  
\$829**  
/each

**Evapo-Rust® Heavy Duty Rust Remover**



**\$5099**  
/each

**Sta-Lube® GL5 Plus  
New Generation™  
Gear Oil**

HD Limited Slip

85W140

1 gal.

SL SL2433



**\$5599**  
/each

**Sta-Lube® GL5 Plus  
New Generation™  
Gear Oil**

Limited Slip

80W90

1 gal.

SL SL2473



CRC 1752536	1 qt.	<b>\$8.29</b>
CRC 1755078	32 oz.	<b>\$13.99</b>
CRC 1752538	1 gal.	<b>\$23.49</b>

CRC 1752540	3.5 gal.	<b>\$66.99</b>
CRC 1752542	5 gal.	<b>\$77.99</b>



## SAVE UP TO 48% ON SELECT PERMATEX PRODUCTS

PTX 81850	Black Super Weatherstrip Adhesive	5 oz.	\$5.69
PTX 57506	Gasket Sealer Seal & Lock	6 ml.	\$6.89
PTX 24200	Blue Threadlocker	6 ml.	\$6.99
PTX 81101	O-Ring Grease	1 oz.	\$7.29
PTX 82194	Ultra Grey Silicone	3 oz.	\$8.49
PTX 82180	Ultra Black Silicone	3 oz.	\$8.59
PTX 51813	Gasket Maker	1.69 oz.	\$14.49
PTX 82195	Ultra Grey Rigid High-Torque RTV Silicone Gasket Maker	13 oz.	\$15.99
PTX 24105	Ultra Black Silicone	13 oz.	\$17.49
PTX 24112	Silicone Brake Parts Lubricant	8 oz.	\$19.49
PTX 29208	Gasket Maker Right Stuff	5 oz.	\$19.49
PTX 24163	Surface Prep Activator for Anaerobic Speeds	4.5 oz.	\$19.49
PTX 24125	Ceramic Extreme Brake Parts Lubricant	8 oz.	\$19.99
PTX 85080	Ultra Black RTV Silicone Gasket Maker	9.5 oz.	\$19.99
PTX 34423	Gasket Sealer Right Stuff Red Power	3 oz.	\$22.99
PTX 24240	Blue Threadlocker	36 ml.	\$24.99
PTX 27140	Red Threadlocker	36 ml.	\$24.99
PTX 33694	Right Stuff Gasket Maker	10 oz.	\$25.99
PTX 81100	Glass Weld Urethane	10.5 oz.	\$25.99
PTX 85224	Right Stuff Gasket Maker	7.5 oz.	\$25.99
PTX 25224	Gasket Maker Right Stuff	7 oz.	\$30.49



# CHEMICALS & COMMODITIES

## TRUFUEL



### TruFuel® Engineered Fuel

RPO 6525538	Pre-Mix Engineered Fuel & Oil 40:1	32 oz.	RPO 6525506	Pre-Mix Engineered Fuel & Oil 40:1	110 oz.
RPO 6525638	Pre-Mix Engineered Fuel & Oil 50:1	32 oz.	RPO 6525606	Pre-Mix Engineered Fuel & Oil 50:1	110 oz.
RPO 6527238	4-Cycle Engineered Fuel	32 oz.	RPO 6527206	4-Cycle Engineered Fuel	110 oz.

## SERVICE CHEMICALS

### TAKE YOUR BUSINESS TO THE NEXT LEVEL

Generate over \$1,300 in profit with our VPS Chemicals



STARTING AT  
**\$34.49** /each

**MAP Sensor Adapter**  
Use With VP055 Fuel Service Canister Tool

VAL 882574	\$34.49
VAL 882576	\$38.99
VAL 884327	\$42.99



**\$36.99** /each

**Replacement Sprayer With Extension**  
Use With VP055 Complete Intake Aerosol Tool  
VAL 883593



VAL VP004	Professional Series Water Pump Lubricant & Protector		<b>\$6.99</b>
VAL 886238	Professional Series CVT Protector Conditioner & Sealer	12 fl. oz.	<b>\$10.99</b>
VAL 679741	Professional Series Complete Fuel System Treatment		<b>\$11.99</b>
VAL 806221	Professional Series Solvent Free Top Treat Oil System Cleaner		<b>\$11.99</b>
VAL 891564	Professional Series Complete Fuel System Treatment		<b>\$11.99</b>
VAL VP093	Professional Series Automatic Transmission Protector Conditioner & Sealer		<b>\$12.99</b>
VAL VP201	Professional Series Diesel Fuel Injector Treatment	12 fl. oz.	<b>\$12.99</b>
VAL VP202	Professional Series Diesel Fuel Injector Treatment	1 qt.	<b>\$25.99</b>
VAL 507460	Professional Series All Season Heater and AC Two-Step Odor Elimination Kit		<b>\$30.99</b>
VAL 884531	Professional Series 'All Engine Clean' System for Gasoline Engines		<b>\$30.99</b>
VAL VP055	Professional Series V055 Complete Intake and Fuel Rail Cleaner Device		<b>\$218.99</b>
VAL 887106	Professional Series® Starter Kit		<b>\$999.99</b>

# CHEMICALS & COMMODITIES

**ROYAL PURPLE**  
SYNTHETIC OIL

SAVE UP TO **41%**

STARTING AT  
**\$8.49**  
/each



RPO 11757	Max-Boost Octane Booster & Stabilizer	16 oz.	<b>\$8.49</b>
RPO 11755	Max-Tane® 6-in-1 Diesel Fuel Additive	20 oz.	<b>\$10.99</b>

RPO 11722	Max-Clean® Fuel System Cleaner & Stabilizer	20 oz.	<b>\$12.49</b>
-----------	---	--------	----------------



SAVE UP TO **44%**

STARTING AT  
**\$8.99**  
/each



SF SF16	Motor Treatment	16 oz.	<b>\$8.99</b>
SF TT16	Trans Tune	16 oz.	<b>\$8.99</b>
SF MP20	Marine Pro	20 oz.	<b>\$11.49</b>

SF SF128	Motor Treatment	1 gal.	<b>\$59.99</b>
SF TT128	Trans Tune	1 gal.	<b>\$59.99</b>
SF MP128	Marine Pro	1 gal.	<b>\$63.99</b>

Pricing Valid as of 6/1/2026 and expires 6/30/2026 but is subject to change based on external factors.  
Any changes to pricing will be disclosed prior to purchase.

# CHEMICALS & COMMODITIES

## LUCAS OIL

STARTING AT  
**\$5.49**  
/each

SAVE  
UP TO  
**45%**



LUC 10020	Fuel Additive Fuel Treatment	5.25 oz.	\$5.49	LUC 10005	Grease - Multi-Purpose Red & Tacky	14.5 oz.	\$7.79
LUC 10301	Grease - Multi-Purpose	14.5 oz.	\$7.29	LUC 10278	Engine Oil Stop Leak	1 qt.	\$9.79
LUC 10669	Deep Clean Fuel System Cleaner	5.25 oz.	\$7.69	LUC 10514	Slick Mist® Fast & Easy Interior Detailer	24 oz.	\$12.59
LUC 11097	Low Viscosity Stabilizer	12 fl oz.	\$7.69	LUC 10160	Slick Mist® Fast & Easy Speed Wax	24 oz.	\$12.69



STARTING AT  
**\$4.79**  
/each

SAVE  
UP TO  
**40%**



NCB 1199	Radiator Stop Leak	11 oz.	\$4.79	NCB 01109	Block Seal Liquid Copper Coolant Leak Fix	18 oz.	\$8.39
NCB 4102	Rislone® Maximum Performance Engine Treatment	16.9 oz.	\$5.19	NCB 1000	High Mileage Engine Repair	16.9 oz.	\$10.49
NCB 01186	Liquid Aluminum Cooling System Stop Leak	16.9 oz.	\$6.99	NCB 1150	High Mileage Cooling System Repair	18 oz.	\$11.19
NCB 1040	Rear Main Seal Repair	16.9 oz.	\$7.89				

# CHEMICALS & COMMODITIES



SAVE UP TO 43%

STARTING AT \$4.99 /each



NCB 91164	Invisible Glass Premium Glass Cleaner	19 oz.	\$4.99	NCB 91154	Tarminator Tar & Sap Remover	10 oz.	\$5.99
NCB 92164	Invisible Glass Premium Glass Cleaner	22 oz.	\$4.99	NCB 91094	More Shine Tire Finish	12 oz.	\$7.99



SAVE UP TO 38%

STARTING AT \$7.99 /each  
Superior Products

**No wiping.  
No drips.  
No runs.  
No mess.**



NCB F96	Cover All	14 oz.	\$7.99
NCB F91	Cover All VOC Compliant	14 oz.	\$9.79

\*F96 is restricted in certain states

Pricing Valid as of 6/1/2026 and expires 6/30/2026 but is subject to change based on external factors. Any changes to pricing will be disclosed prior to purchase.

# VISIBILITY



## SEE BETTER, DRIVE SAFER NIGHTVISION™



UP TO  
**39%  
OFF**

### LED SEALED BEAMS

- Ultra-bright white 6000K color, 1,900 Lumens
- Up to 15x the life of a standard sealed beam
- Durable powder coated aluminum housing
- Meet or exceed OEM Specifications for performance and life
- Industry leading warranty

**THE #1 SUPPLIER OF WHOLESALE  
VEHICLE LAMPS IN NORTH AMERICA**

### Lamp Cabinet Program

- Popular lamp types readily on hand
- Easily wall-mounted or placed on flat surface



### Miniature Lamps Cabinet

Item Number: LMP MINICABN

**\$160.00**

Cabinet Coverage is 71%  
Includes 180 Lamps and a  
FREE Cabinet

### Capsule Lamps Cabinet

Item Number: LMP CAPSCABN

**\$192.00**

Cabinet Coverage is 77%  
Includes 20 Lamps and a  
FREE Cabinet

# rain-x® WIPER BLADES

SAVE UP TO **57%**

### Rain-X® Vision Blade

RNX 810016	16 in.	\$13.49
RNX 810017	17 in.	\$13.49
RNX 810018	18 in.	\$13.49
RNX 810019	19 in.	\$13.49
RNX 810020	20 in.	\$13.49
RNX 810021	21 in.	\$13.49
RNX 810022	22 in.	\$13.49
RNX 810024	24 in.	\$13.49
RNX 810026	26 in.	\$13.49
RNX 810028	28 in.	\$13.49

### Rain-X® Latitude Water Repellency Wiper Blade

RNX 50792722	14 in.	\$15.49
RNX 50792792	18 in.	\$15.49
RNX 50792802	19 in.	\$15.49
RNX 50792812	20 in.	\$15.49
RNX 50792822	21 in.	\$15.49
RNX 50792832	22 in.	\$15.49
RNX 50792752	24 in.	\$15.49
RNX 50792732	26 in.	\$15.49
RNX 50792732	28 in.	\$15.49
RNX 50792732	17 in.	\$15.49
RNX 50792742	16 in.	\$15.49
RNX 50792762	15 in.	\$15.99

### Rain-X® Silicone AdvantEdge® Wiper Blade

RNX 830014	14 in.	\$25.49
RNX 830016	16 in.	\$25.49
RNX 830017	17 in.	\$25.49
RNX 830018	18 in.	\$25.49
RNX 830019	19 in.	\$25.49
RNX 830020	20 in.	\$25.49
RNX 830021	21 in.	\$25.49
RNX 830022	22 in.	\$25.49
RNX 830024	24 in.	\$25.49
RNX 830026	26 in.	\$25.49
RNX 830028	28 in.	\$25.49



# SHOP SUPPLIES

**Gojo**

SAVE UP TO 34%

STARTING AT \$15.29 /each



NCB 2356	Cherry Gel Pumice Hand Cleaner	1/2 gal.	\$15.29
NCB 0955	Natural Orange™ Pumice Hand Cleaner	1 gal.	\$17.29
NCB 0972	Supro Max™ Hand Cleaner	1/2 gal.	\$18.59
NCB 2358	Cherry Gel Pumice Hand Cleaner	1 gal.	\$29.49
NCB 0979	Supro Max™ Hand Cleaner	1 gal.	\$31.59

\$10.99 /each

**NAPA® Citrus Orange Pumice Hand Cleaner**  
1 gal.  
NCB 5125



\$11.99 /each

**NAPA® Citrus Orange Smooth Lotion Hand Cleaner**  
1 gal.  
NCB 5025



SAVE UP TO 37%

\$14.49 /each

**NAPA® Waterless Hand Cleaner**  
4.5 lb.  
NCB 5005



\$14.49 /each

**NAPA® Waterless Pumice Hand Cleaner**  
4.5 lb.  
NCB 5105



**TOOL BOX BRAND**

STARTING AT \$2.79 /each

SAVE UP TO 49%



NCB 5440030	Blue Shop Towels	55 sheets	\$2.79
NCB 55202	Blue Shop Towels	200 Towel Box	\$13.69

NCB 5820201	Extra Thick Professional White Rags	200 Towel	\$13.89
NCB 54416	Blue Shop Towels	6 Pack Of 55 Towel Rolls	\$16.29

Pricing Valid as of 6/1/2026 and expires 6/30/2026 but is subject to change based on external factors. Any changes to pricing will be disclosed prior to purchase.

# ACCESSORIES



## PERFORMANCE INTAKE SYSTEMS<sup>3</sup>



GUARANTEED TO INCREASE  
 ▣ **HORSEPOWER AND TORQUE**

▣ **EASY TO INSTALL**  
 IN 60 MINUTES OR LESS

ENGINEERED TO PROVIDE  
 ▣ **IMPROVED ENGINE SOUND**

UP TO  
 ▣ **75,000 MILES**  
 BETWEEN CLEANINGS<sup>2</sup>

\*Limitations apply, for details visit [knfilters.com/warranty](http://knfilters.com/warranty). ISO 5011 test protocol. Efficiency varies by application. <sup>2</sup>Under normal highway driving conditions. <sup>3</sup>Some intakes are not legal for sale or use on any pollution controlled motor vehicle in California. See [knfilters.com](http://knfilters.com) for CARB status on each part for a specific vehicle.

**Spectre**  
 PERFORMANCE



### MULTIPLE STYLES AND COLORS AVAILABLE

/// ENGINEERED TO ADD  
 HORSEPOWER & TORQUE

/// HIGH-PERFORMANCE  
 WASHABLE AIR FILTER

/// HIGH-QUALITY ALUMINUM  
 TUBING

/// DIRECT FIT BOLT-ON  
 REPLACEMENT



**DRYFLOW**



- ▣ Up to 50,000 miles between cleanings. (Under normal highway driving conditions.)
- ▣ Simply spray and rinse your filter to wash, and re-install when dry.

COTTON AIR FILTER  
**CLEANER AND  
 FILTER OIL KIT**

- ▣ RESTORE FILTER EFFICIENCY AND REMOVE ROAD GRIME

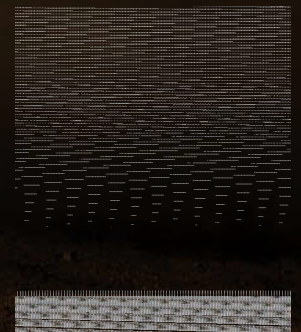

# ACCESSORIES

## WeatherTech®

FOR COMPLETE DETAILS AND TO PLACE ORDERS, GO TO [pro.NAPAprmlink.com](http://pro.NAPAprmlink.com)

### CUSTOM PRODUCT APPLICATIONS AVAILABLE.



From the hood to the bed, we've got you covered inside and out.



Made in USA

© 2026 MacNeil IP LLC

Pricing Valid as of 6/1/2026 and expires 6/30/2026 but is subject to change based on external factors. Any changes to pricing will be disclosed prior to purchase.



## NAPA IS FUELING THE NEXT GENERATION OF TECHNICIANS

TWO UNIQUE SCHOLARSHIPS WITH ONE COMMON GOAL.



The Carlyle Tools MAX IMPACT Scholarship recognizes students who embody the same fierce determination and cutting-edge skills that define the Carlyle spirit.

Each month, we award \$2,500 plus a fully stocked professional-grade toolbox to one exceptional student who refuses to settle for standard. These scholarships go to those with the instincts to become technical leaders in their field. We're not just funding education; we're aiming to unleash a new breed of professionals that will reshape the industry landscape. For more information visit [TechForce.org/Carlyle/](https://TechForce.org/Carlyle/)



## NAPA | SKILLS USA SCHOLARSHIP

SkillsUSA and NAPA have launched a scholarship program awarding eight \$2,500 scholarships to support students pursuing education in transportation repair fields. This initiative addresses the national shortage of skilled technicians by empowering committed young talent in automotive, collision, diesel, and motorsports repair pathways. Eligible applicants must be registered SkillsUSA members who are high school seniors or post-secondary students continuing their education or training in these critical industry areas.

We recognize the vital role that skilled technicians play in keeping our communities moving. This scholarship represents the NAPA commitment to empowering young talent and shaping the future of our industry. Applications for the NAPA + SkillsUSA scholarship close on June 30th, 2026. For more information visit

<https://apply.mykaleidoscope.com/program/NAPA2026>

**450k+ Automotive Technicians needed by 2028**

## AUTEL MAXITPMS

### MaxiTPMS® TS900 Cabinet Bundle **Call Store for Price**

- Part #ATDTS900CAB2
- Professional Metal TPMS Cabinet with Lock 18" X 26" X 12"
  - Includes the TS900K-8 tools and sensors, one additional bulk pack of sensors, one bulk pack of valves, the TS508WF in a cardboard box, and a TPMS cabinet



**28**  
1-SENSORS INCLUDED

## NEW HEAVY DUTY TPMS SERVICE

### MaxiTPMS® ITS600 CV **Call Store for Price**

Part #ATD700420

- Complete TPMS Service tool for Commercial Vehicles
- Industry-leading coverage for TPMS-enabled Trucks, Trailers, Buses
- Program Autel MX-Sensor CVS-A01433 MHz Sensor to replace OE and programmed aftermarket sensors
- Separate Tractor & Trailer interfaces display up to 46 wheels & 12 axles
- Includes Deutsch 6 and 9-pin, and UNI-U4 DLC adapters



## UNIVERSAL 1-SENSORS - REPLACE 99% OF OE SENSORS ON THE ROAD



### MaxiTPMS® 1-Sensor **Call Store for Price**

- Part #ATD1SENSOR
- Combined Frequency: 315MHz & 433MHz
  - Interchangeable Valve Stems
  - Rubber Valve Stem Included
  - Sold Individually

### MaxiTPMS® 1-SensorM **Call Store for Price**

- Part #ATD1SENSORM
- Aluminum Valve Stem Included



## MX-Sensor CVS-A01 TPMS Sensor for Commercial Vehicles

### **Call Store for Price** Part #ATD300170

- Includes metal band to attach sensor to rim, compatible with rims sized 14 to 24.5-inches



### **Call Store for Price** Part #ATD300190

- Includes fabric band to attach sensor to rim, compatible with rims sized 14-17.5-inches



### **Call Store for Price** Part #ATD300210

- Includes fabric band to attach sensor to rim, compatible with rims sized 17.5 to 24.5-inches

## SAVE SPACE & MONEY WITH 1-SENSOR BULK PACKS



### MaxiTPMS® 1-Sensor 20 Packs

- Call Store for Price** Part #ATD300010
- Package of 20 1-Sensors with Rubber Valves

- Call Store for Price** Part #ATD300060
- Package of 20 1-Sensors with Aluminum Valves



### MaxiTPMS® 1-Sensor 240 Bulk Pack

- Call Store for Price** Part #ATD300050
- Package of 240 Autel 1-Sensors with Rubber Valve Stems

## AUTEL TPMS SERVICE TOOLS + 1-SENSOR KITS



### MaxiTPMS® TS508WF-8 KIT

- Call Store for Price** Part #ADT700020
- TS508WF Kit Including 8 1-Sensors
  - TS508 Wi-Fi handheld TPMS tool
  - Updated software via Wi-Fi
  - Program Autel 1-Sensors
  - Exclusive TPMS Status Screen



### MaxiTPMS® ITS600 **Call Store for Price**

- Part #ATDITS600
- Compatible with Autel BLE Sensor
  - TPMS Service + 4 Service Resets
  - Activate, Read & Relearn All Known Sensors
  - Program Autel MX-Sensors

### MaxiTPMS® ITS600K3 Kit **Call Store for Price**

- Part #ATD700130
- ITS600 Kit Including 8 1-Sensors

### MaxiTPMS® TS900

**Call Store for Price** Part #ATDTS900

- Activate, Read, and Relearn ALL known TPMS sensors, including Tesla OE sensors
- Program Autel 1-Sensors and Bluetooth Low Energy (BLE) TPMS sensors
- All Systems Diagnostics with bi-directional controls, Active Tests and Special Functions
- Industry-leading Relearn-by-OBD coverage and extensive Service Menu with 40-plus service tasks



## LASER TIRE TREAD EXAMINER + EASY TO SHARE REPORTS

### MaxiTPMS® TBE200

**Call Store for Price** Part #ATDTBE200

- Tire Tread and Brake Disc Wear Examiner
- Laser-Enabled; No Need to Remove Tire
- Full Color Touchscreen Display Illustrates Wear
- 2 Cameras to Document Tire Damage
- Scan Tire Identification Number (TIN)
- Tire health report QR code for easy sharing



# CARLYLE

BUILT DIFFERENT

CarlyleTools.com

## WRENCHES

STARTING AT  
**\$28<sup>99</sup>**

### CARLYLE ADJUSTABLE WRENCHES

CHT <b>CAW8</b>	8 in. Adjustable Wrench	<b>\$28.99</b>
CHT <b>CAW10</b>	10 in. Adjustable Wrench	<b>\$31.99</b>
CHT <b>CAW12</b>	12 in. Adjustable Wrench	<b>\$45.99</b>
CHT <b>CAW15</b>	15 in. Adjustable Wrench	<b>\$59.99</b>
CHT <b>CAW18</b>	18 in. Adjustable Wrench	<b>\$94.99</b>
CHT <b>CAW24</b>	24 in. Adjustable Wrench	<b>\$179.99</b>



## WHILE SUPPLIES LAST

**\$484<sup>99</sup>** /each

### DELUXE 4 DRAWER TOOL CART

- CHT **C4DRCARTGG** Gritty Gray
- CHT **C4DRCARTMO** Midnight Oil
- CHT **C4DRCARTVG** Venom Green



## BATTERY CHARGERS

**\$130<sup>00</sup>**

### 12/24V CHARGER

CHT **CCBC12V20AEA**



**\$245<sup>00</sup>**

### 12V JUMP STARTER

CHT **CCJS12V425A**



**\$600<sup>00</sup>**

### 12/24V WHEEL CHARGER

CHT **CCWC1224V80A**



# TOOLS & EQUIPMENT

## FILL-RITE

STARTING AT  
**\$210<sup>42</sup>**  
/each

SAVE  
UP TO  
**49%**



BK 8213594	Fuel Transfer Hand Pumps	\$210.42	BK 8213602	Transfer Pump - Rotary, AC	\$686.53
BK FR8	12V DC 8 GPM Fuel Transfer Pump with Nozzle	\$334.54	BK FR4211H	12V DC 20 GPM Fuel Transfer Pump with Meter & Nozzle	\$859.53
BK 8215871	Transfer Pump Kit - 20 gal/hr, 12 Volt, DC	\$523.57	BK 8213603	Transfer Pump - Rotary, AC	\$860.36

**\$69<sup>99</sup>**  
/each

**CHARGE IT!® 12/6/2 Amp 12 Volt  
Battery Charger**  
SOR 4512



**\$69<sup>99</sup>**  
/each

**SOLAR 12V Digital Battery &  
System Tester**  
SOR BA9



**\$109<sup>00</sup>**  
/each

**Jump-N-Carry 1000A 12V  
Lithium Jump Starter**  
SOR JNC305



**\$129<sup>00</sup>**  
/each

**Booster PAC™ ES2500 1100 Peak  
Amp 12 Volt Jump Starter**  
SOR ES2500



**\$295<sup>00</sup>**  
/each

**Truck PAC™ ES6000  
3000 Peak Amp 12  
Volt Jump Starter**  
SOR ES6000



**\$310<sup>00</sup>**  
/each

**CHARGE IT!® 40/20/2/230A 12/24  
Volt Wheeled Battery Charger**  
SOR 4745



# TOOLS & EQUIPMENT



**15% OFF REGULAR PRICING**

REG. PRICE: \$104  
PROMO PRICE:  
**\$103<sup>96</sup>**

20624  
6 LB HEAD, 24"  
B.A.S.H.® SLEDGE HAMMER



REG. PRICE: \$74  
PROMO PRICE:  
**\$74<sup>93</sup>**

30316  
3 LB HEAD, 16"  
B.A.S.H.® CROSS PEIN HAMMER



REG. PRICE: \$119  
PROMO PRICE:  
**\$119<sup>20</sup>**

20824  
8 LB HEAD, 24"  
B.A.S.H.® SLEDGE HAMMER



REG. PRICE: \$54<sup>99</sup>  
PROMO PRICE:  
**\$57<sup>28</sup>**

32414  
24 OZ HEAD, 14"  
B.A.S.H.® BALL PEIN HAMMER



**CRC SmartWasher®**

**SAVE UP TO 39%**



## BIOREMEDIATING Parts Washing Systems

SW FL4	OzzyMat® Multi-Layer Fluid Activation Mat		<b>\$22.49</b>
SW SW3	OzzyJuice® SW-3 Truck Grade Degreasing Solution	5 gal.	<b>\$104.49</b>
SW SW4	OzzyJuice® SW-4 Heavy Duty Degreasing Solution	5 gal.	<b>\$104.49</b>
SW SW7	OzzyJuice® SW-7 Parts/Brake Cleaning Solution	5 gal.	<b>\$104.49</b>
SW SW8	OzzyJuice® SW-8 Aircraft & Weapons Degreasing Solution	5 gal.	<b>\$104.49</b>
SW 1000872	BenchtopPRO Bioremediating Parts Washer Kit		<b>\$469.99</b>



**Donaldson**  
FILTRATION SOLUTIONS



## TRUSTED BY 8 OF THE TOP 10 OEMs. AVAILABLE AT NAPA.

When it comes to keeping heavy-duty equipment running strong, trust the name OEMs have relied on for years: Donaldson. From air, fuel, lube, and hydraulic filters to complete aftermarket solutions, Donaldson delivers the performance and protection your fleet needs.



SCAN FOR EXPANDED  
PRODUCT INFORMATION



©2026 Donaldson Company, Inc.

### TOP FILTRATION SOLUTIONS FOR ON-HIGHWAY APPLICATIONS

**CATERPILLAR ENGINES**

Fuel Filter: P551311

**CUMMINS ENGINES**

Lube Spin-On: P553000

**CUMMINS ISM, ISX**

Lube Spin-On: P559000

**DAVCO 380/382**

Fuel Cartridge: P550463

**DETROIT DD13/DD15/DD16**

Coolant Filter: P551008

**DETROIT SERIES 60**

Fuel Filter: P556915  
Lube Spin-On: P552100

**FREIGHTLINER CENTURY  
CLASS/COLUMBIA**

Air Primary: P527682

**FREIGHTLINER M2 SERIES**

Air Primary: P607955

**KENWORTH T660/T800**

Air Primary: P616056

## GET ALL THE OE FILTERS YOU NEED AT NAPA AUTO PARTS



GENUINE  
PARTS

**ACDelco**



**Motorcraft**

## PRODUCT CATEGORIES AVAILABLE NOW

- Oil filters
- Air filters
- Cabin filters
- Fuel filters
- Transmission filters



Visit [NAPAonline.com](http://NAPAonline.com) or [Pro.NAPAProlink.com](http://Pro.NAPAProlink.com) to see these products and more

# REPLACEMENT PARTS



## NEW MUST-SEE SOLUTIONS™

Our latest innovations that service professionals need to know about.

### ENGINE OIL FILTER CAP

Cracked or stripped filter cap making oil changes difficult? Dorman offers replacements for many popular vehicles that match the fit and function of the original equipment cap for a reliable repair.

**NOE 917-051**

Buick 2021-13, Chevrolet 2021-07, Pontiac 2010-05, Saturn 2009-08, Suzuki 2012-11, 2009-07



### ENGINE OIL DIPSTICK

Dorman offers replacement oil and transmission dip sticks and tubes for many popular vehicles. All match the fit and function of the original equipment part for a reliable repair.

**NOE 918-606**

Ford F-150 2014-11, Mustang 2014-11, Lincoln Mark LT 2014-11

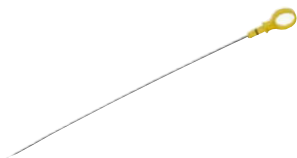

### ENGINE OIL DRAIN PLUG REMOVAL KIT

This convenient oil pan drain plug removal tool kit includes everything you need to easily remove and avoid damaging plastic drain plugs from a wide variety of popular vehicle years, makes and models.

**NOE 899-3599-1**

Universal

### ENGINE OIL DRAIN PLUG



The factory drain plug on certain vehicles causes oil to splash on chassis components during an oil change. This Dorman® OE FIX® plug features a downward-facing drain hole and convenient twist tabs for easy, spill-free servicing.

**NOE 819-8417-1**

Ford 2025-15, 2012-11, Lincoln 2025-16



NEW



### ENGINE OIL DRAIN PLUG TECH TRAY

This new Engine Oil Drain Plug Assortment contains the most popular oil drain plugs. Many styles are offered, including Pilot Point, Universal and Differential. Kit contains 23 part numbers and 79 pieces.

**NOE 821-5527-1**

Universal

# #1 REMAN PARTNER FOR NAPA AUTO PARTS

**TRANSMISSIONS ENGINES  
TRANSFER CASES DIFFERENTIALS**

Industry-leading warranty  
World-class customer service

Order via Storefront or call your supporting DC

Product and Availability Questions:

**(800) 705-4849**

**NAPA@ETEREMAN.COM**

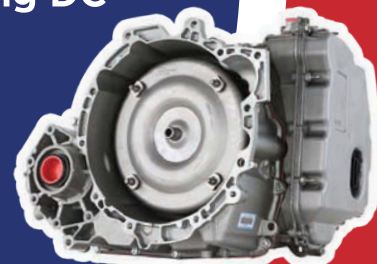
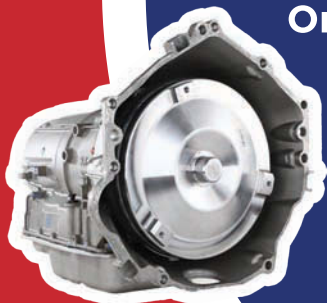

# REPLACEMENT PARTS



## Your Trusted Transmission Supplier

Quality - Availability - Customer Service

- Wide range of 4 and 6 speeds
- Hundreds of SKUs in stock
- Same day/next day shipping for stocked units
- ASE certified technicians
- Real time technical assistance
- Award-winning training: in person & online

(877) 866-8372

customerservice@moveras.com

**10 speeds now in stock**



G12148 G12149 G12151 G12152 G12153

## BRAKES



Get a \$25 Prepaid Visa® Card\* for every

**\$200** SPENT ON  
**BREMBO BRAKES**



Must be a NAPA Installer Rewards member or NAPA Auto Care for Prepaid Visa® Card offer

\*This Card is issued by Sunrise Banks N.A., St. Paul, MN 55103, Member FDIC, pursuant to a license from Visa U.S.A. Inc. This card may be used everywhere Visa debit cards are accepted. Use of this card constitutes acceptance of the terms and conditions stated in the Cardholder Agreement. Card expires 12 months from issuance, per the "Valid Thru" date printed on the card. Prepaid Visa® Cards will be issued by IS Results and mailed within 10-12 weeks after the promotion has ended.



# TEMP PRODUCTS



Purchase \$1,500 worth of products, receive a

**\$50 PREPAID VISA® CARD\***

**All NAPA Temp PNs included (May 1-July 31, 2026)**

Purchases reset each month, months cannot be stacked consecutively. Promotion is applicable to PROLink purchases only.

\*This Card is issued by Sunrise Banks N.A., St. Paul, MN 55103, Member FDIC, pursuant to a license from Visa U.S.A. Inc. This card may be used everywhere Visa debit cards are accepted. Use of this card constitutes acceptance of the terms and conditions stated in the Cardholder Agreement. Card expires 12 months from issuance, per the "Valid Thru" date printed on the card. Prepaid Visa® Cards will be issued by IS Results and mailed within 10-12 weeks after the promotion has ended.



OE



# ALL THE POWER WITH PARTS YOU TRUST

Built for durability, corrosion resistance, and smoother, faster starting, GM Genuine Parts OE Alternators and Starters are the go-to choice for the high electrical loads of most of today's vehicles. Find them at NAPA Auto Parts stores and [pro.napaprolink.com](http://pro.napaprolink.com)

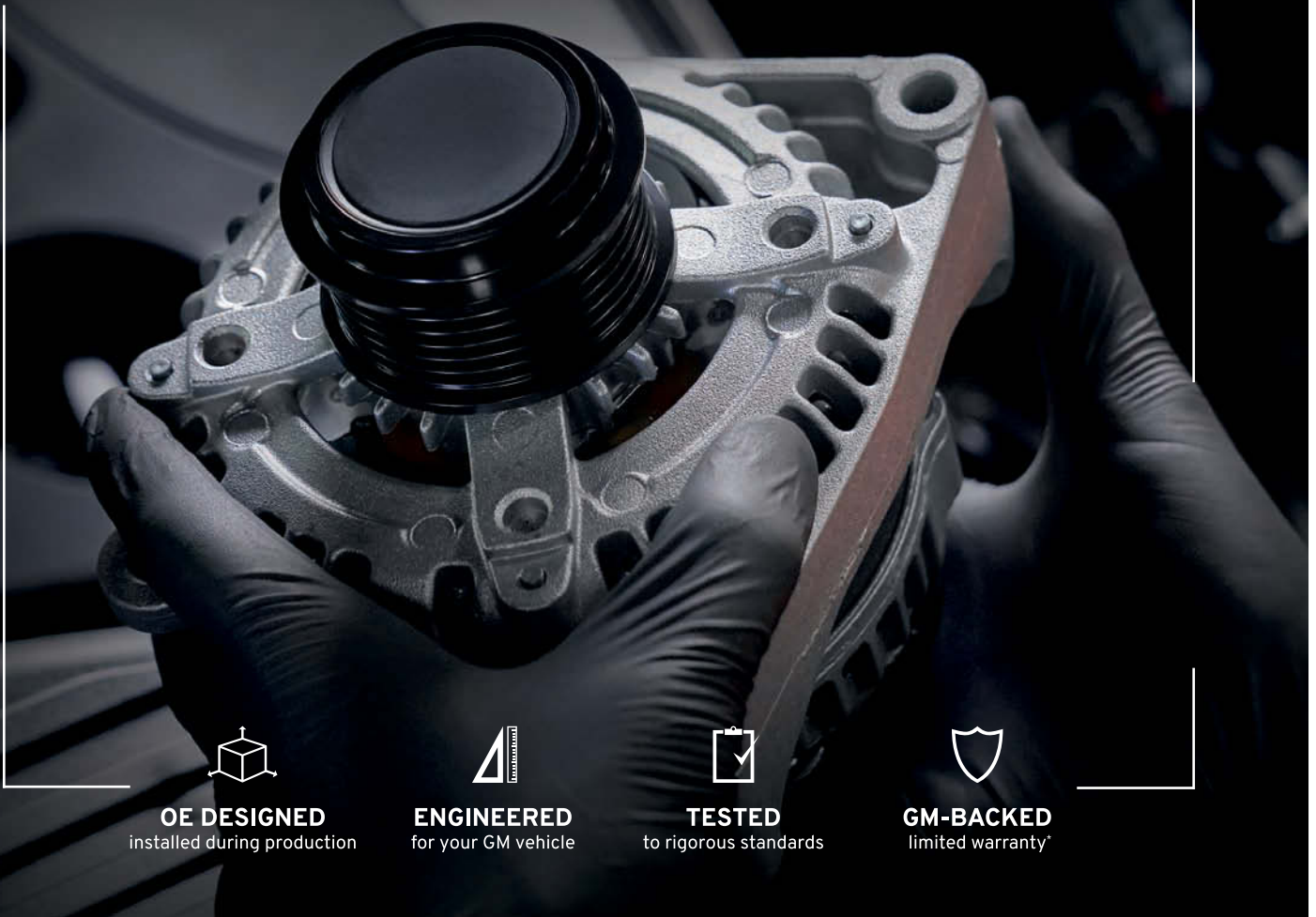

**OE DESIGNED**  
installed during production



**ENGINEERED**  
for your GM vehicle



**TESTED**  
to rigorous standards



**GM-BACKED**  
limited warranty\*



Available at [pro.napaprolink.com](http://pro.napaprolink.com)

\*Effective on parts purchased April 1, 2018, and later to the original retail purchaser. Contact seller for limited warranty part details, qualifications, and possible labor coverage.  
©2026 General Motors. All rights reserved.



## RADIATORS AND CONDENSERS



RNR NC4283A



RNR NR2370B

Purchase \$500 in RNR products during the promotional period and receive a

**\$25 PREPAID VISA® CARD\***

Limit One Per Customer.

Only NAPA Installer Rewards members and Auto Care Centers are eligible. Contact your local NAPA AUTO PARTS store to enroll in the 2026 NAPA Installer Rewards program.

\*This Card is issued by Sunrise Banks N.A., St. Paul, MN 55103, Member FDIC, pursuant to a license from Visa U.S.A. Inc. This card may be used everywhere Visa debit cards are accepted. Use of this card constitutes acceptance of the terms and conditions stated in the Cardholder Agreement. Card expires 12 months from issuance, per the "Valid Thru" date printed on the card. Prepaid Visa® Cards will be issued by IS Results and mailed within 10-12 weeks after the promotion has ended.





## ECHLIN® IMPROVED VVT SOLENOIDS

### Design Improvements for Durability

NAPA® Echlin® VVT Solenoids match the design and performance of the original, including critical lubrication grooves. Additionally, our Solenoids feature an improved, solid valve body design for increased strength and durability.

Echlin® VVT Solenoids feature better designs, better materials, and improved durability.

**That is what's in our box.  
WHAT'S IN YOUR BOX?™**

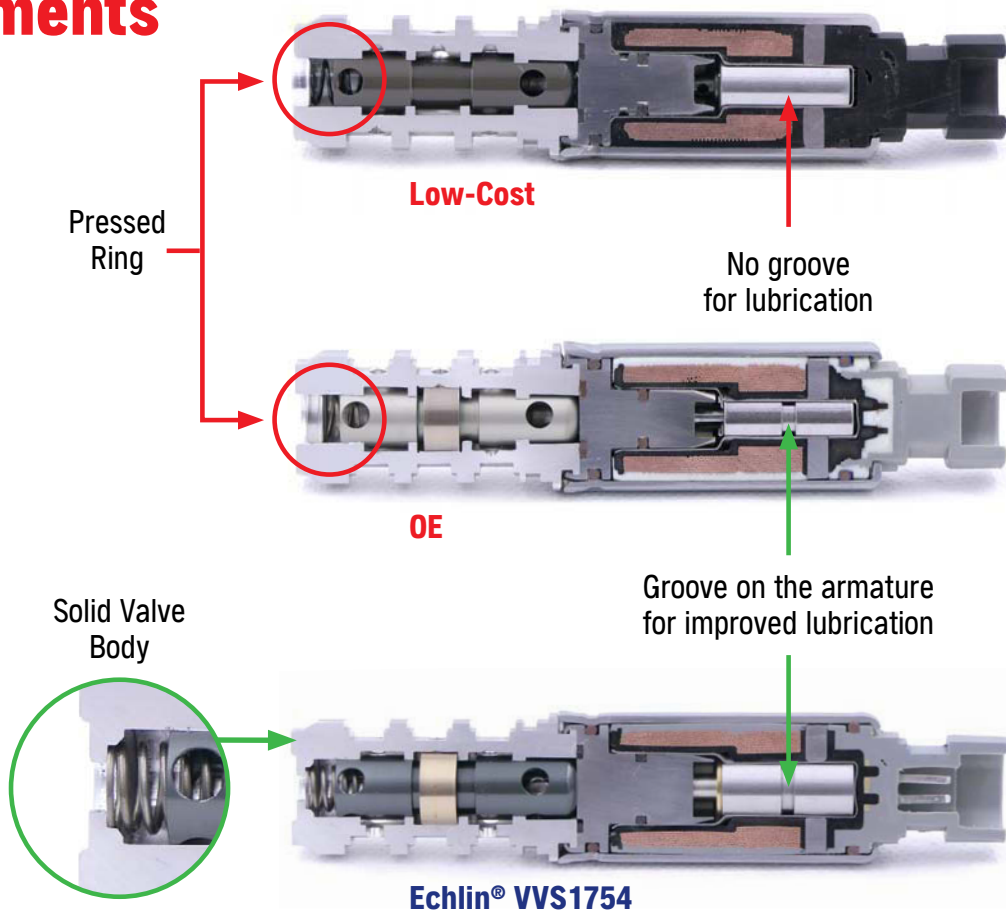

**LOOKS RIGHT. FITS RIGHT. PERFORMS RIGHT.**

[NAPAEchlin.com](http://NAPAEchlin.com)



Purchase \$250 or more of Echlin® Oil Pressure and/or Variable Valve Timing Components on PROLINK and get a **\$25 Prepaid Visa® Card\***

June 1-30, 2026. Limit one redemption per installer.  
NAPA® Echlin® Group Codes: ECH 085, 110, and 120



\* Card is issued by Sunrise Banks N.A., St. Paul, MN 55103, Member FDIC, pursuant to a license from Visa U.S.A. Inc. This card may be used everywhere Visa debit cards are accepted. Use of this card constitutes acceptance of the terms and conditions stated in the Cardholder Agreement. Card expires 12 months from issuance, per the "Valid Thru" date printed on the card.